

# EmiratesGreen

الامارات الخضراء لتجارته المعدات الكهربائية والميكانيكية  
**EmiratesGreen** Electrical & Mechanical Trading Est.

P.O. Box: 110507 | Phone: +971 2 491 0 757 | Abu Dhabi, U.A.E  
Email: [solar@emiratesgreen.com](mailto:solar@emiratesgreen.com) | Web: [www.emiratesgreen.ae](http://www.emiratesgreen.ae)



**Grid-Interactive  
GTFX AND GVFX  
INVERTER/CHARGER  
Programming Manual**

## WARRANTY SUMMARY

Dear OutBack Customer,

Thank you for your purchase of OutBack products. We make every effort to assure our power conversion products will give you long and reliable service for your renewable energy system.

As with any manufactured device, repairs might be needed due to damage, inappropriate use, or unintentional defect. Please note the following guidelines regarding warranty service of OutBack products:

- Any and all warranty repairs must conform to the terms of the warranty.
- All OutBack equipment must be installed according to their accompanying instructions and manuals with specified over-current protection in order to maintain their warranties.
- The customer must return the component(s) to OutBack, securely packaged, properly addressed, and shipping paid. We recommend insuring your package when shipping. Packages that are not securely packaged can sustain additional damage not covered by the warranty or can void warranty repairs.
- There is no allowance or reimbursement for an installer's or user's labor or travel time required to disconnect, service, or reinstall the damaged component(s).
- OutBack will ship the repaired or replacement component(s) prepaid to addresses in the continental United States, where applicable. Shipments outside the U.S. will be sent freight collect.
- In the event of a product malfunction, OutBack cannot bear any responsibility for consequential losses, expenses, or damage to other components.
- Please read the full warranty at the end of this manual for more information.

### About Outback Power Systems

OutBack Power Systems is a leader in advanced energy conversion technology. Our products include true sine wave inverter/chargers, maximum power point charge controllers, system communication components, as well as breaker panels, breakers, accessories, and assembled systems.

### Notice of Copyright

FX Series Inverter/Charger Programming Manual © 2007 All rights reserved.

### Disclaimer

UNLESS SPECIFICALLY AGREED TO IN WRITING, OUTBACK POWER SYSTEMS:

(a) MAKES NO WARRANTY AS TO THE ACCURACY, SUFFICIENCY OR SUITABILITY OF ANY TECHNICAL OR OTHER INFORMATION PROVIDED IN ITS MANUALS OR OTHER DOCUMENTATION.

(b) ASSUMES NO RESPONSIBILITY OR LIABILITY FOR LOSS OR DAMAGE, WHETHER DIRECT, INDIRECT, CONSEQUENTIAL OR INCIDENTAL, WHICH MIGHT ARISE OUT OF THE USE OF SUCH INFORMATION. THE USE OF ANY SUCH INFORMATION WILL BE ENTIRELY AT THE USER'S RISK.

### Contact Information:

OutBack Power Systems  
19009 62nd Ave. NE

Arlington, WA 98223 Phone (360)435-6030 • Fax (360)435-6019    [www.outbackpower.com](http://www.outbackpower.com)

Date and Revision • September 2007 REV A

# TABLE OF CONTENTS

Warranty Summary.....	1
Certificate of Compliance.....	3
Welcome to the OutBack Power Systems FX Series Inverter/Charger System .....	4
Safety.....	4
FX Series Inverter/Charger Programming.....	5
Concerns .....	5
Options.....	5
Components and Connections.....	6
Powering Up.....	7
Stacking Options .....	9
Classic Series .....	9
Stacking And Assigning FX Status .....	9
Master .....	9
Classic Slave.....	9
Programming the FXs.....	10-12
Master.....	13
Classic Slave.....	13
Power Save Levels .....	14
AC ON .....	15-16
Auxiliary (AUX) Functions .....	17
List of AUX Functions.....	20
Adjustable AUX Output Functions.....	20
Battery Charging Instructions.....	23
Maintenance .....	23
FX Default Values .....	24
Warranty.....	25
Product Registration.....	26
10-Year Limited Warranty (California).....	27-29

# OUTBACK GTFX AND GVFX CERTIFICATE OF COMPLIANCE TO UL1741 UTILITY-INTERACTIVE INVERTERS

OutBack GTFX and GVFX inverters comply with UL1741 for utility-interactive inverters. The following specifications refer to exporting power to a simulated utility source of less than 1% voltage total harmonic distortion (THD).

- The output of the GTFX or GVFX exceeds the minimum power factor of 0.85 specified in UL1741 section 45.2.2. Typical power factor is 0.96 or better.
- The THD of the RMS (root/means/square) current is less than 5 percent of the fundamental under the conditions of UL1741 section 45.4.2. Individual odd harmonics do not exceed the limits specified in Table 45.1 of UL1741. Individual even harmonics do not exceed the limits specified in Table 45.2 of UL1741.
- The GTFX and GVFX inverters cease to export power to the simulated utility source under islanding conditions specified in section 46.3 of UL1741.
- The GTFX and GVFX inverters cease to export power to the simulated utility source after the output voltage and frequency of the simulated utility source are adjusted to each of the conditions specified in Table 46.1 of UL1741 within the time specified in that table. All production GTFX and GVFX inverters are tested to comply with the table below as specified in section 46.2 of UL1741.

---

Condition	Voltage Range (VAC)	Frequency (Hz)	Seconds Allowed	Cycles Allowed
A	<60	60	0.1	6
B	<=60 to <105.6	60	2	120
C	>=105.6 to <=132	60	no cessation	no cessation
D	>132 to <164.4	60	2	120
E	>=164.4	60	0.033	2
F	120	<59.3	0.1	6
G	120	>60.5	0.1	6

---

# WELCOME TO THE OUTBACK POWER SYSTEMS FX SERIES INVERTER/CHARGER SYSTEM

The FX Series Inverter/Charger offers a complete power conversion system—DC to AC, battery charging, and an AC Transfer Switch—and can be used for stand-alone or back-up applications.

OutBack Power Systems does everything possible to assure the components you purchase will function properly and safely when installed as instructed according to local and national electrical codes. Please read all of the following instructions and the instructions that come with any OutBack components included in your power system. Further instructions on individual FX set-ups as well as systems assemblies are included with the *FX and VFX Series Inverter/Charger Installation Manual*.

The OutBack Power Systems FX Series Inverter/Charger is ETL listed to UL1741 (Inverters, Converters, Controllers, and Interconnection System Equipment for Use with Distributed Energy Resources). All Mobile FX Series Inverter/Chargers are ETL listed to UL 458

Grounding Instructions – Each FX should be connected to a grounded, permanent wiring system. For most installations, the negative battery conductor should be bonded to the grounding system at one (and only one) point in the DC system. All installations must comply with all national and local codes and ordinances. System grounding as required by the National Electric Code, ANSI /NFPA 70-1996, is the responsibility of the system installer.

The equipment ground is marked with this symbol: 

The *Grid-interactive FX and VFX Inverter/Charger Programming Manual* covers safety and the programming or “stacking” multiple FXs using the OutBack Power Systems MATE.

## IMPORTANT SAFETY INSTRUCTIONS

### General Precautions

1. Use caution whenever working around electricity, electrical components, and batteries. There is always a potential for shocks, burns, injury, and even death if an installer or user comes in contact with electricity.
2. Read all instructions and cautionary markings on the FX, the batteries and all appropriate sections of this manual as well as other component manuals before using the system.
3. Be sure each system FX is securely installed according to the FX and VFX Series Inverter/Charger Installation Manual.
4. Follow all local and national electrical codes when installing OutBack equipment and components.

### NOTE:

- Neither the GTFX nor the GVFX is designed to be used with a generator. They are strictly for grid-interactive usage.
- An OutBack MATE is required to program the FXs beyond their default values.
- If an OutBack Charge Controller is in use, be sure to read its manual for optimum operation with a grid-interactive FX.
- When powered up, the GTFX/GVFX will automatically sense if a utility grid is present and then connect to it after a 30-second delay. There is a five-minute delay before battery charging starts, which is done as a default action to assure the batteries are charged should the grid fail. The inverter can sell power to the grid after the batteries are charged.
- UL 1741 requires approved surge protection for a grid-interactive system. The optional OutBack FLEXware Surge Protector meets this requirement.

## GRID-INTERACTIVE FX SERIES INVERTER/CHARGER PROGRAMMING

**NOTE:** Please see the *FX and VFX Series Inverter/Charger Installation Manual* to install, wire, and connect each FX Series Inverter/Charger. This programming manual assumes all FXs have been installed and are ready to program according to the way they were wired. To familiarize yourself with the programming concepts, please read through the entire manual before programming your system.

Up to two grid-interactive FXs can be combined and wired or “stacked.”

- Stacking FXs does not refer to physically placing one FX on top of another, but to how they are wired within the system and then programmed for operation. Stacking allows all the FXs to work together as a single system.
- Stacking assigns the FXs to power individual legs of the system and to operate at certain times; this order is assigned using the MATE.

**NOTE:** An OutBack MATE with a code revision of 3.30 or higher is required to recognize and program Grid-Interactive FXs. When multiple FXs are used, each needs to be assigned a status—Master or Slave (at least one FX must be a Master).

- The Master FX is the primary and most heavily used unit. The loads and demands of the system determine when and which Slaves are used. A Slave FX assists when the load demands are more than the Master FX can handle alone.
- This is an orderly process as long as the user assigns each FX correctly. This is mainly a matter of paying attention to the Port number for each FX when programming with the MATE.

### Stacking Concerns

FXs should be wired and stacked appropriately to their individual power system. Problems can occur when:

- An FX is incorrectly wired.
- An FX plugged into a HUB Port is mistakenly programmed (assigned the wrong status) or misidentified.

An easy rule to remember is any FX wired to a specific phase or leg must be programmed to that phase.

### Stacking Options

- The Grid-Interactive FX Series Inverter/Chargers can be stacked in Classic Series only, which is limited to two grid-interactive FXs.
- A HUB-4 or HUB-10 must be included to stack grid-interactive FXs. The Grid-Interactive FX cannot do time-of-day selling.
- If the utility grid fails, the GTFX or GVFX seamlessly transfers the loads to the battery bank. When the utility grid reappears, the Grid-Interactive FX automatically recharges the battery bank in case of future power outages.

**NOTE:** The FW-X240 Auto Transformer cannot be used for stacking with a Grid-Interactive FX system. The FW-X240 can be used to step-up the AC output of a single Grid-Interactive FX system, however.

## Components and Connections:

1. With all AC and DC breakers OFF, connect all FXs to the HUB with individual lengths of CAT5 cable.

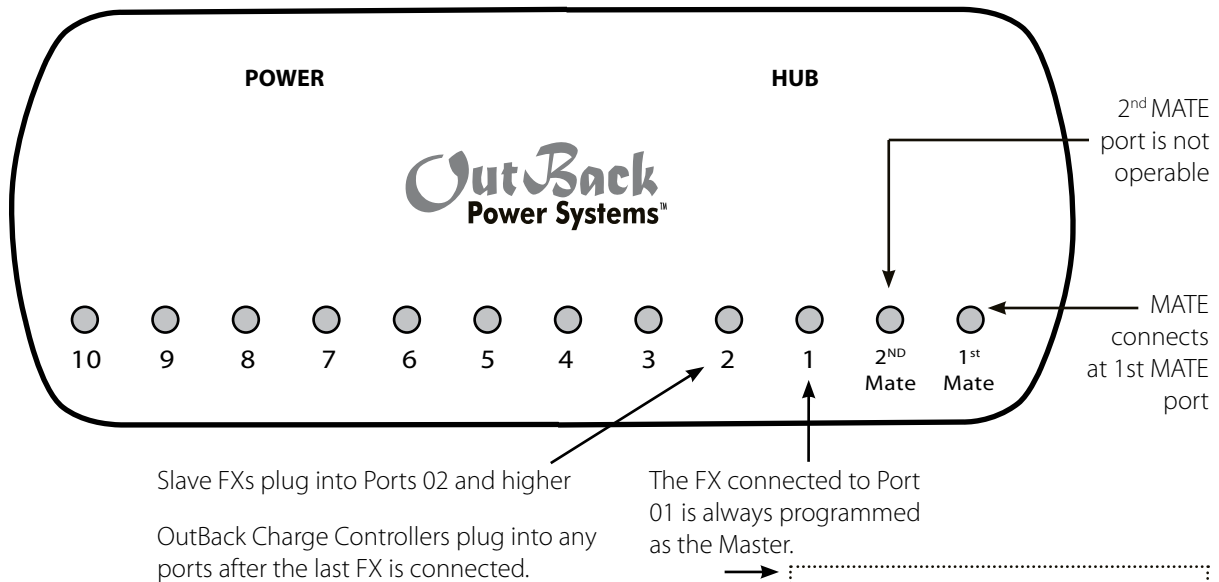
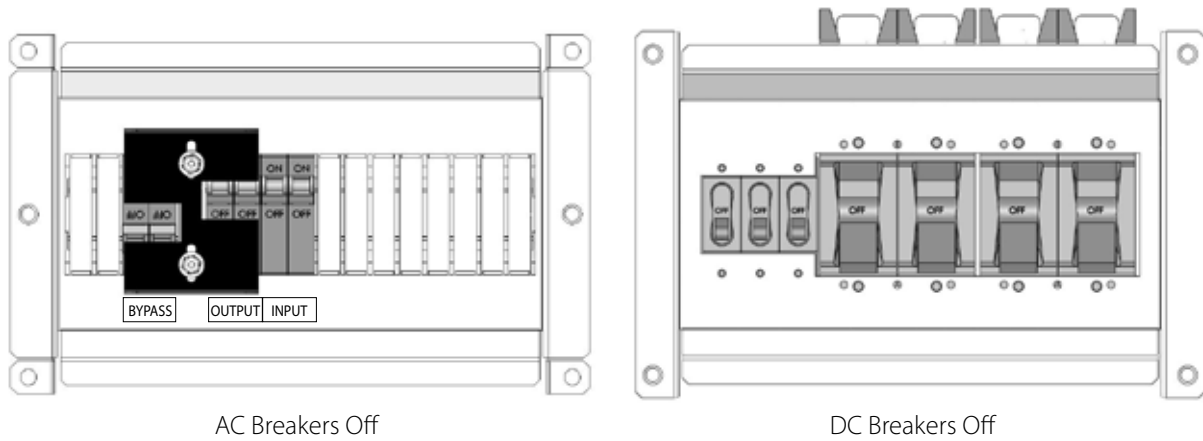

- Connect the OutBack MATE after all other components, including any OutBack Charge Controllers, have been connected and powered up.
- Components installed after powering up the system will require repolling the MATE (please see page 8).
- With the MATE, a user assigns a status and stacking value to the FX on each Port. These status and value assignments can be changed at any time as long as the Master FX is plugged into HUB Port 01.

- "Master" for one and two-phase systems
- The Master FX is always considered to be the leg one or L-1 phase.

**NOTE:** Pay attention to the Port number on the screen! Be sure the FX whose status and stacking value you're changing is the one you mean to change.



2. With the FXs connected to the HUB, turn only the DC breakers ON and power up the components. All AC breakers should be OFF.

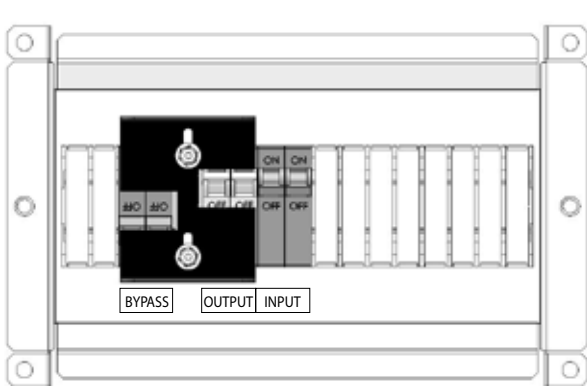

AC Breakers Off

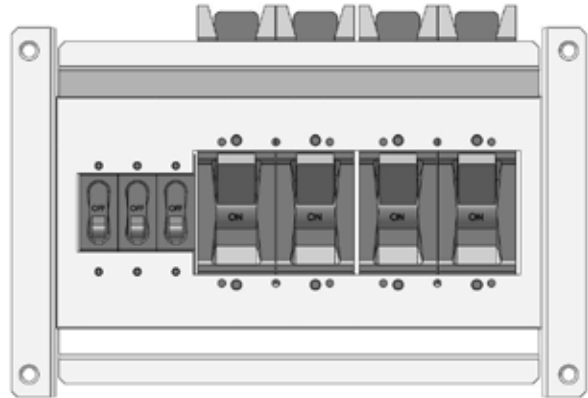

DC Breakers On

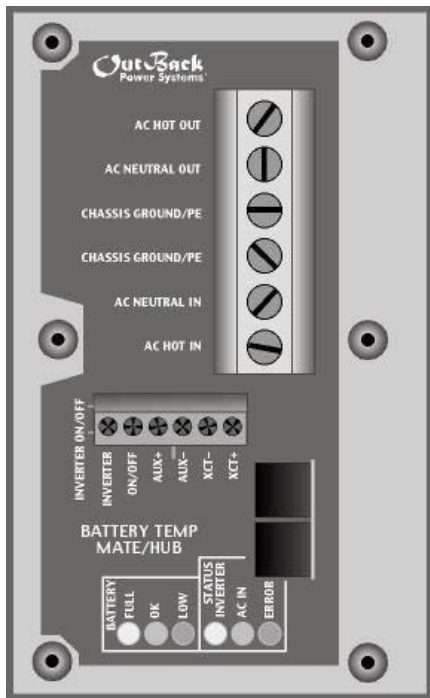

LED Color	LED Action	LED Indicates
Green	Solid GREEN →	Inverter ON
	Flashing GREEN →	Search Mode or Slave Power
	Off →	Inverter OFF
Yellow	Solid YELLOW →	AC Source is Connected
	Flashing YELLOW →	AC Input Live-Waiting to Connect to the FX
	Off →	No AC Input Present
Red	Solid RED →	Error-Error Message, displays on the MATE
	Flashing RED →	Warning: Non-critical FX fault, the MATE can access this information

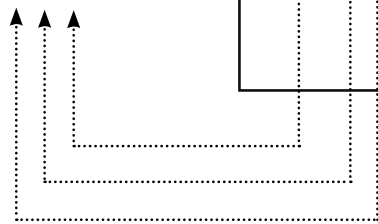

**NOTE:** Powering up the FXs can cause the red ERROR STATUS light to blink. After 5-10 seconds, the green INVERTER light should be bright and the ERROR and AC IN lights dark. The FX is now producing AC output voltage.

3. After powering up the components, connect the MATE to the HUB.



- a) Plug the MATE into the 1st MATE Port on the HUB.
- b) The MATE will power up and should recognize any component connected to the HUB.
- c) The MATE can then program the FXs.
- d) The fifth MATE screen ("Port Assignment") should display all the FXs and any Outback Charge Controllers in the system.

**MATE Screens**

PATH	→	→	→	→
G'day Mate	(C) 2004 OutBack Power Systems	Version Code a.aa  Serial #xxxxxxx Screen EE b.bb	Searching for Devices  HUB Found	Port Assignment 1> FX 2> FX 3> CC 4> CC 5> 6> 7> 8> 9> 10> 2M>

4. To verify the MATE recognizes each HUB connected FX and OutBack Charge Controller, disconnect and then either (a) reconnect the MATE to view its boot-up and repoll sequence or (b) follow this path to manually repoll:

PATH	→	→	→	→
MAIN----- 12.15:30p	SETUP-----  choose device:	SETUP/MATE/PAGE1 mate code rev: 402 choose category:	SETUP/MATE/PAGE2 choose category:	SETUP/MATE/COMM choose produce:
SUM STATUS SETUP ADV	FX MATE	CLOCK CNT GLOW PG2	PG1 SUMRY COMM MAIN	BACK REPOLL PC DEBUG



The FXs are now ready to be programmed according to the stacking options described in the next section.

## STACKING OPTIONS

OutBack Grid-Interactive FXs can be stacked in Classic Series only.

### CLASSIC STACKING

- Two FXs are wired to two 120 VAC output legs producing 240 VAC between them.
- Each FX powers one leg and acts independently of the other, but both combine when 240 VAC is required for a load.
- The AC input must be 240 split phase VAC.

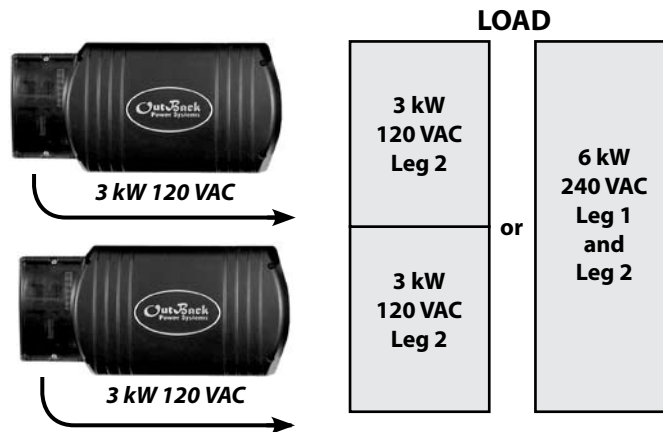

### STACKING AND ASSIGNING FX STATUS

Stacking Phases/Assigning FX Status (in order as they appear on the MATE):

1. Master
2. Classic Slave

Use the MATE to establish the order or hierarchy of all the system FXs by designating one as the Master and one as the Classic Slave.

#### 1. Master

- This is the default ranking of every FX. It applies to one-phase and two-phase systems.
- One Master FX is established for every multiple FX system.
- Each Grid-Interactive FX can be a Master as long as each is connected to a separate AC output leg (both HOT and NEUTRAL)
- If one Grid-Interactive FX is designated as the system's only Master, it is always considered to be the Leg 1 phase.

#### 2. Classic Slave

- Classic Slave is the designation of the second FX in a two-inverter, split-phase system that produces 240 VAC without using an FW-X240 Auto Transformer.
- This FX is plugged into Port 02 of the HUB and is considered to be the L2 phase.

## PROGRAMMING THE FXS

Once the MATE recognizes each FX (and OutBack Charge Controller), push and hold the first two soft keys simultaneously to return to the MAIN menu. To program the FXs, go to the ADV/FX/STACK menu on the MATE navigating with the following steps:

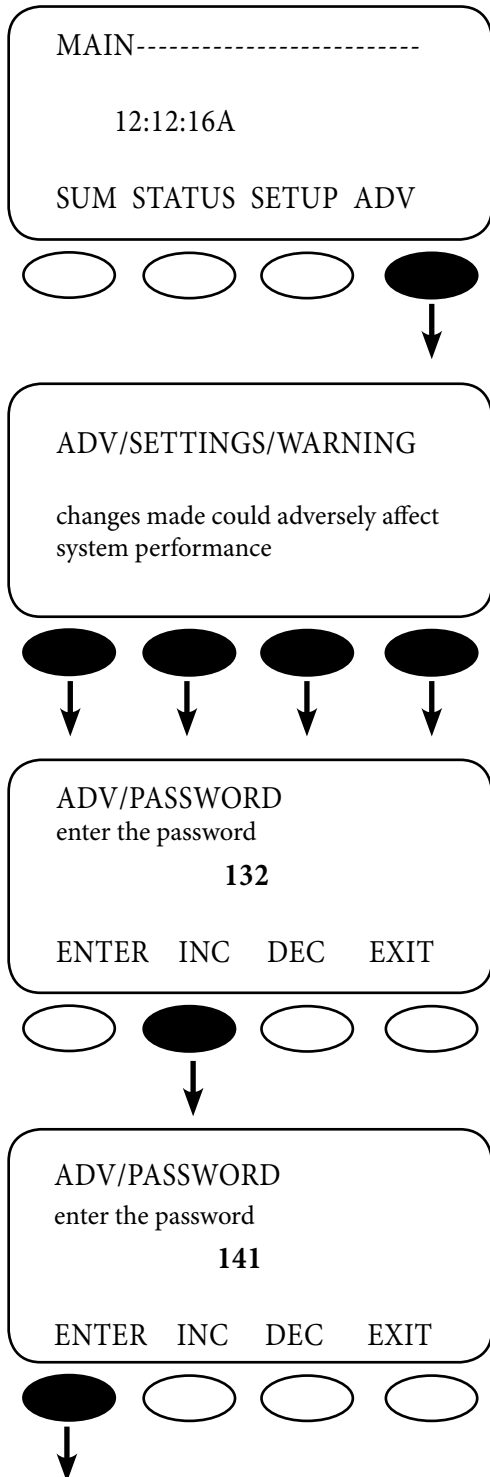

- Press the **<ADV>** soft key.

**NOTE:** Pressing and holding the first two soft keys at the same time will always bring up the Main Menu screen.

- Push any soft key on the ADV/SETTINGS/WARNING screen and go to the ADV/PASSWORD screen.

- The screen displays <132>. Press the **<INC>** button until it scrolls to the password 141.

- Push the **<ENTER>** soft key.

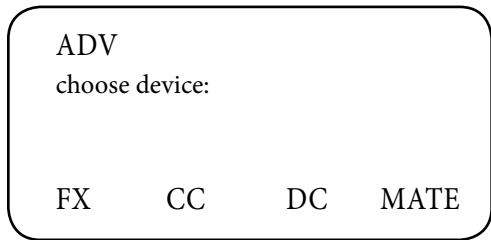

- In the ADV menu, press the **<FX>** soft key.

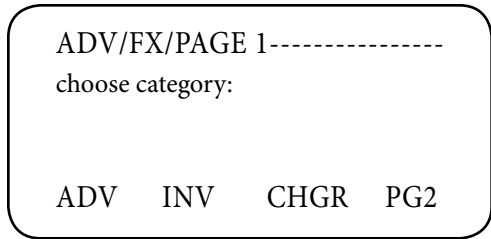
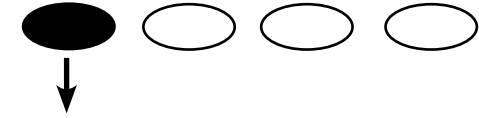

- On the ADV/FX/PAGE 1 screen, press the **<PG2>** soft key and go to the ADV/FX/PAGE2 screen.

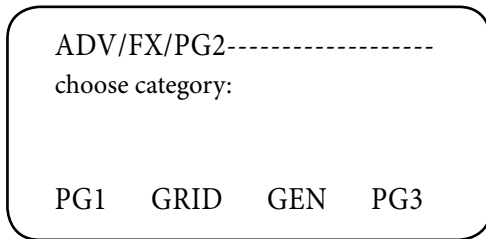
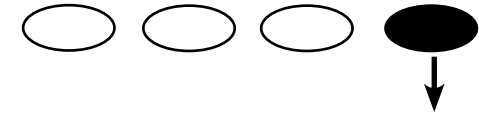

- Press the **<PG3>** soft key which leads to the ADV/FX/PAGE3 screen.

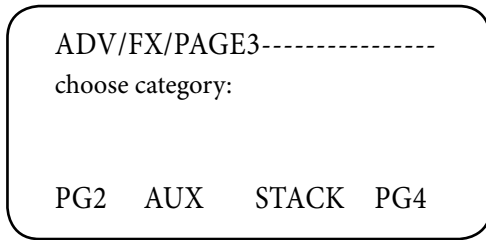
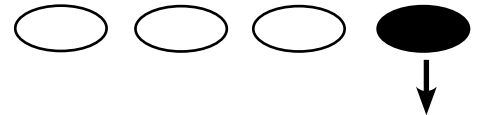

- On the ADV/FX/PAGE3 screen, press the **<STACK>** soft key.

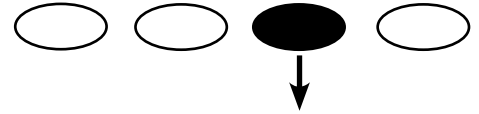

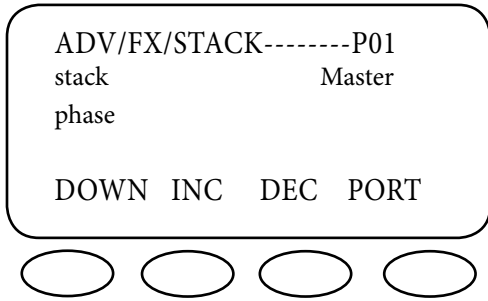

- Stacking the FX Inverter/Chargers begins on this screen. See specific stacking procedures in the next section.

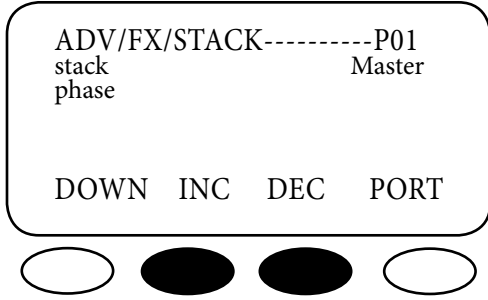

- Port 01 always takes the Master FX.
- Pressing the **<PORT>** soft key changes the HUB Port whose value you wish to adjust.

Pressing the **<INC>** or **<DEC>** soft keys changes the stacking phase.

## MASTER

With the Port 01 FX as the Master, press the **<PORT>** soft key to change the remaining Ports and designate the remaining FXs as Slaves. The MATE screen for Port 02 will look like this:

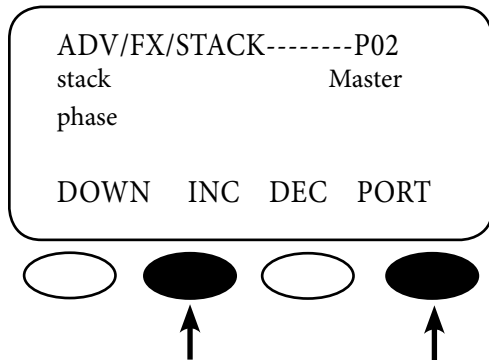

- The MATE is now ready to program the FX plugged into Port 02 of the HUB.
- Master is the factory default value for each grid-interactive FX.

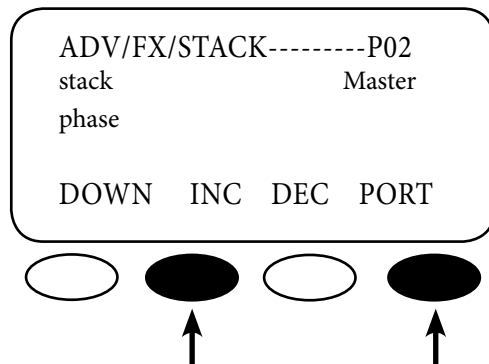

- Pressing the **<INC>** soft key will keep the MATE's attention on Port 02, but will change the stack phase to Classic Slave screen. Port 02 will then be assigned as a Classic slave. You can change the stacking phase by pressing the **<INC>** or **<DEC>** soft keys and change to a different port by continuously pushing the **<PORT>** soft key.

**NOTE:** There are no **<OK>** or **<DONE>** commands in the stacking menu. Whichever value—Master or Slave—shows up on the MATE screen will be assigned to the chosen Port (and FX) upon leaving that screen. It's important to watch the Port number in the top right corner of each screen to be sure you've assigned it the desired status.

## CLASSIC SLAVE

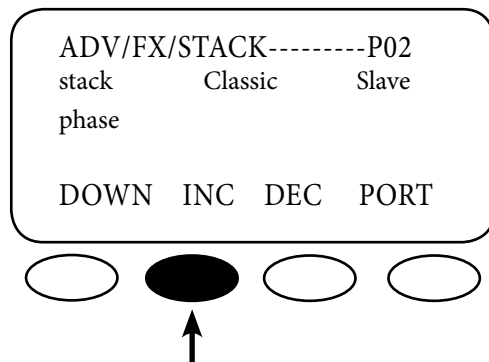

- P02 is now assigned as a Classic Slave.

## POWER SAVE LEVELS

Depending on the model, each FX consumes 20-25 watts of power when it remains on, even if it isn't actively inverting or charging. OutBack offers a power save feature for its non-grid-interactive systems, but is not available for grid-interactive systems. The power save level screens can be viewed from any stacking screen, *but the default values should remain unchanged in a grid-interactive system.*

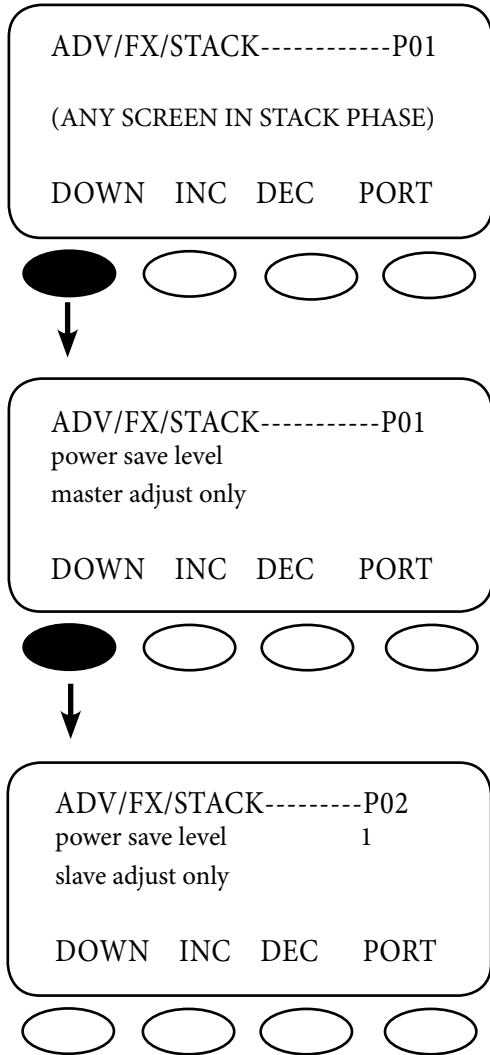

- Press the **<DOWN>** soft key once to view the power save level master adjust only screen

- Press the **<DOWN>** soft key to view the power save level slave adjust only screen.

- Do not adjust these values when using a grid-interactive FX.



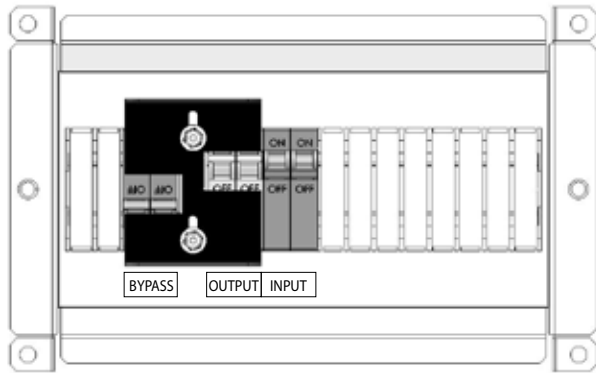

## AC ON

- With the programming completed, turn the AC output breakers ON with the AC BYPASS on the AC breaker panel switched to NORMAL.

**NOTE:** If you are using the FW-X240 Auto Transformer for step-up functioning, turn on its breaker now. Otherwise, go to the next step.

Verify the AC voltage output through the MATE following path:

PATH	→	→	→	
MAIN----- 12.15:30p	SETUP----- choose device:	STATUS/FX/PAGE1----- choose category:	Float P00 inv 0.0Kw zer 0.0kw chg 0.0kw buy 0.0kw	STATUS/FX/METER--P00 output 117 vac voltage
SUM STATUS SETUP ADV	FX CC DC MAIN	MODES METER BATT PG2	DOWN STATUS PORT	DOWN UP TOP PORT



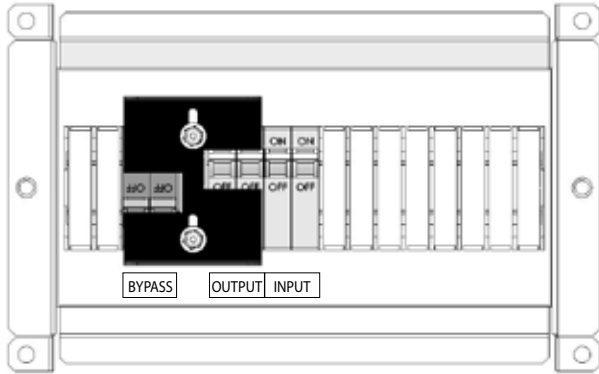

- Turn the AC input breakers ON.

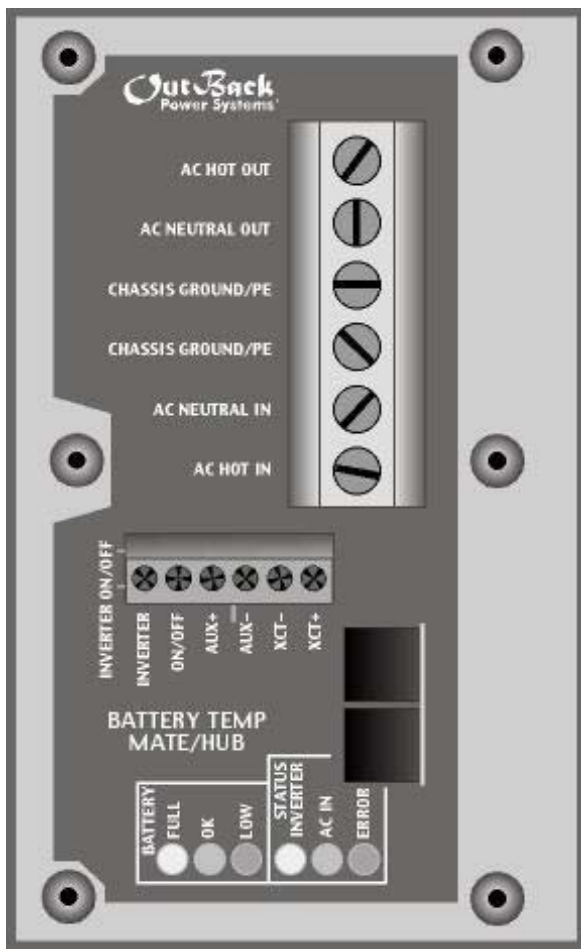

If the FX's AC source is available, the yellow AC IN STATUS light will blink. The FX will connect to the utility grid when the voltage is within 108-140 VAC and the frequency between 59.3-60.5 Hz. After about 30 seconds, the AC IN light should stop blinking and stay lit. A five-minute waiting period begins before selling or charging can occur. The FX can then perform a battery charge using the available AC.



## AUXILIARY (AUX) FUNCTIONS

The AUX output provides a 12 VDC, 0.7 ADC max output at the AUX terminals to control either DC or AC external loads. Typical loads include sending a fault alarm signal or running a small fan to cool the FX.

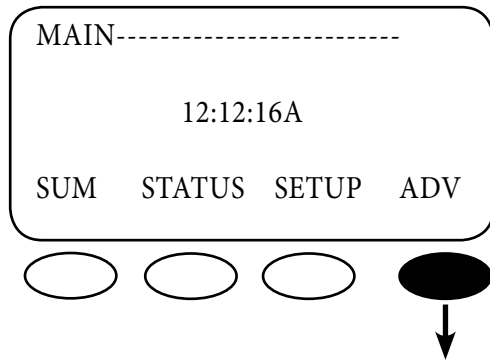

- Press the **<ADV>** soft key.

**NOTE:** Pressing and holding the first two soft keys at the same time will always bring up the Main Menu screen.

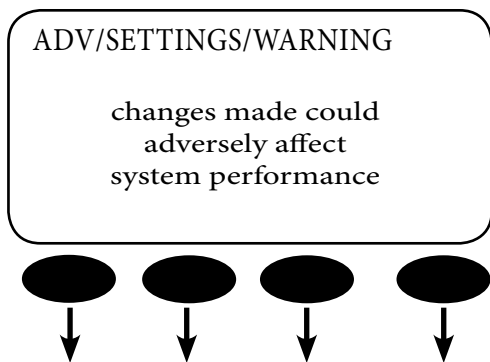

- Push any soft key on the ADV/SETTINGS/WARNING screen and go to the ADV/PASSWORD screen.

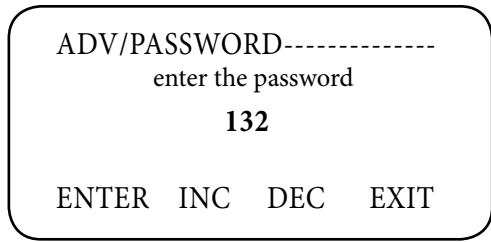

- The screen displays <132>. Press the **<INC>** button until it scrolls to the password 141.

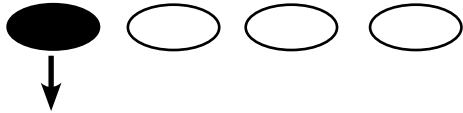
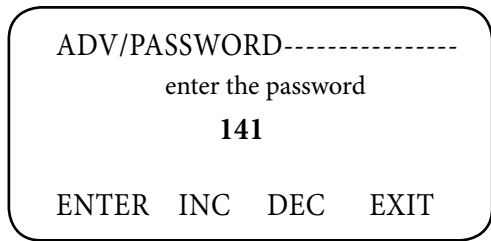

- Push the **<ENTER>** soft key.

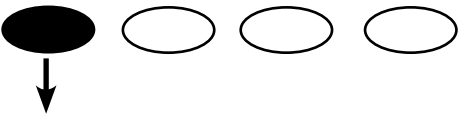
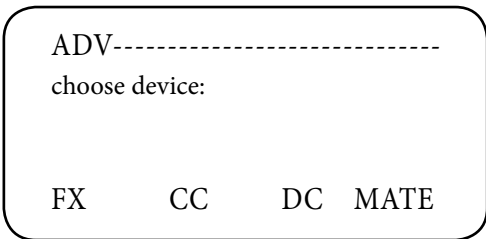

- In the ADV menu, press the **<FX>** soft key.

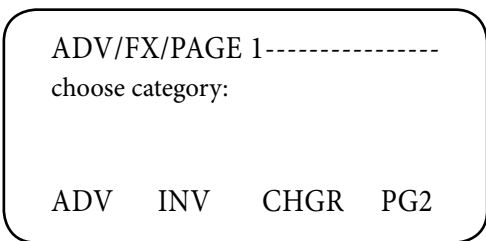

- On the ADV/FX/PAGE 1 screen, press the **<PG2>** soft key and go to the ADV/FX/PAGE2 screen.

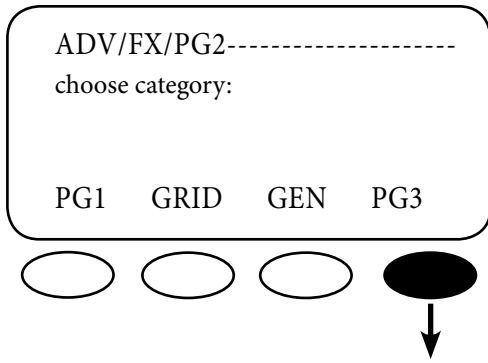

- Press the **<PG3>** soft key which leads to the ADV/FX/PAGE3 screen.

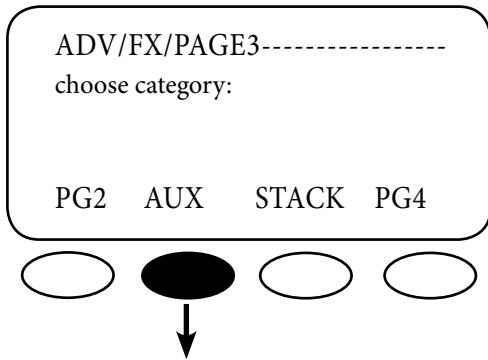

- On the ADV/FX/PAGE3 screen, press the **<AUX>** soft key to adjust the AUX output set points and operation.

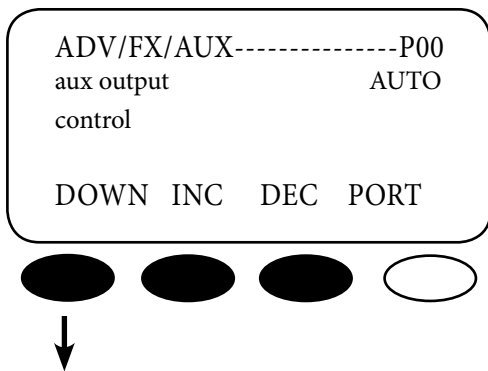

- *Selecting the **<INC>** or **<DEC>** soft keys changes the mode of the AUX.*
- AUTO allows the AUX to perform a selected AUX OUTPUT FUNCTION, determined in the following screens.
- OFF disables the AUX.
- ON activates the AUX regardless of the selected function.
- Press the **<DOWN>** soft key to select on an AUX OUTPUT FUNCTION

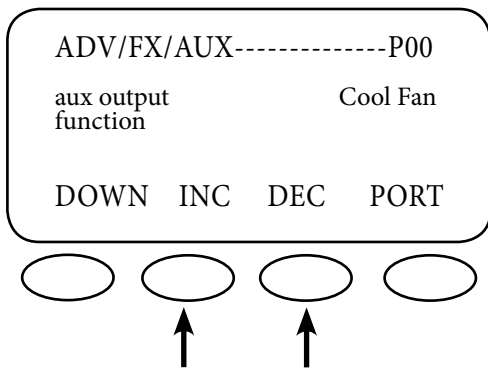

**There are nine AUX OUTPUT FUNCTIONS:**

- Cool Fan
- Divert DC
- Divert AC
- AC Drop
- Vent Fan
- Fault
- GenAlert
- Load Shed
- Remote

Pressing the **<INC>** or **<DEC>** soft keys changes the aux output function.

Pressing either the **<INC>** or **<DEC>** soft key will bring up another AUX OUTPUT FUNCTION

## LIST OF AUX FUNCTIONS

- **Cool Fan** activates the standard TurboFan which cools the FX.
- **Divert DC** and **Divert AC** allows the AUX to divert excess renewable energy to a DC or AC load, respectively. This allows control of energy sources such as wind turbines or hydro-generators. When using Divert AC, the AUX output will shut off if the inverter is overloaded.
- **AC Drop** is activated when an AC power source disconnects from an FX. An indicator, such as an alarm, connected to the AUX warns a user that AC power is no longer available.
- **Vent Fan** provides 0.7 amps to run a 12 VDC fan for removing hydrogen from the battery compartment. Vent Fan can operate automatically when the VENTFAN ON voltage set point is exceeded or it can operate intermittently by adjusting the VENTFAN OFF PERIOD.
- In **Fault** mode, the AUX can send an alarm signal via radio, pager, or telephone device when the FX enters into an error condition. Fault mode can also be used to log error conditions by triggering an event recording device.
- **GenAlert**, through a 12VDC relay, will tell the system to start a two-wire type generator when the battery voltage falls below a certain set point. GenAlert can be adjusted according to the shortfall battery voltage, the amount of time spent at this voltage, the recharged voltage and amount of time at this voltage before GenAlert is de-energized.
- **Load Shed** energizes the AUX to reduce the load demand on the batteries and the inverter function, thus acting as a load management system.
- Setting the AUX to **Remote** allows a message sent through the serial port on the MATE to switch the AUX on and off.

**NOTE:** Using Advanced Generator Start (AGS) overrides any programmed AUX function.

## ADJUSTABLE AUX OUTPUT FUNCTIONS

There are four AUX functions whose settings can be adjusted by the user:

- Diversion
- Vent Fan
- GenAlert
- Load Shed

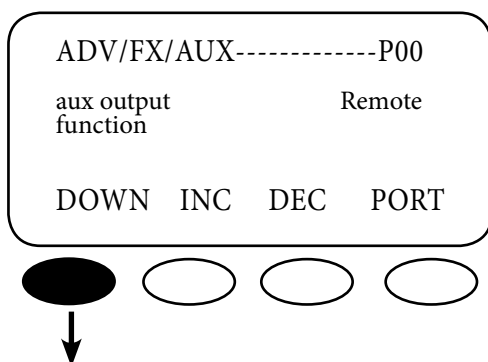

- From the Remote aux output function screen, press the **<DOWN>** soft key

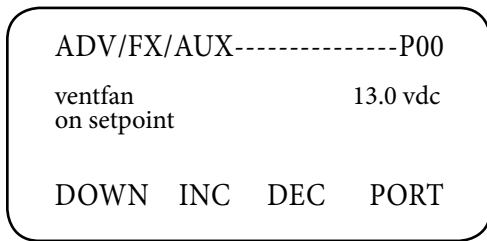
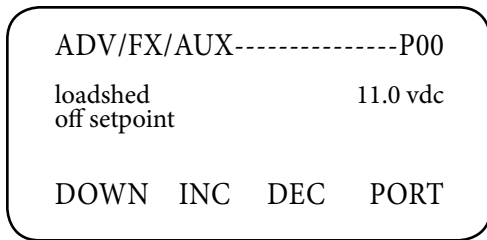
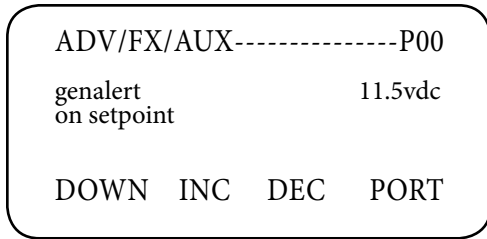
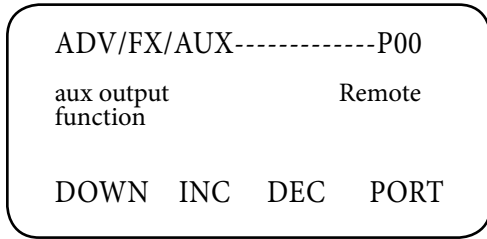

- From the Remote aux output function screen, press the **<DOWN>** soft key. This will bring up the first of several screen used to adjust which ever mode you have chosen for the AUX function.

- The *genalert on setpoint* functions are not available for grid-interactive FXs. Press the **<DOWN>** soft key three times to view the *loadshed off setpoint* screen.

- The *loadshed off setpoint* is the battery voltage which triggers the AUX to reduce the inverter and battery loads. When the battery voltage drops below this value for three seconds, the AUX powers a DC coil relay to disconnect an AC load. Once triggered, loadshed remains on for at least three minutes. The *loadshed off setpoint* is adjustable from 10 VDC-14 VDC in 0.1 VDC increments using the **<INC>** and **<DEC>** soft keys. Press the **<DOWN>** soft key to bring up the ventfan on setpoint.

- When the AUX is set to ventfan, a fan ventilates a battery enclosure. The *ventfan on setpoint* establishes the battery voltage which energizes the AUX and thus the fan for a one minute period. The voltage setting has a range of 10.0 VDC-16.0 VDC in 0.1 VDC increments using the **<INC>** and **<DEC>** soft keys. Recharging causes batteries to emit mostly hydrogen gas; higher recharging voltages emit more gas. Press the **<DOWN>** soft key to view the *ventfan off period* screen.

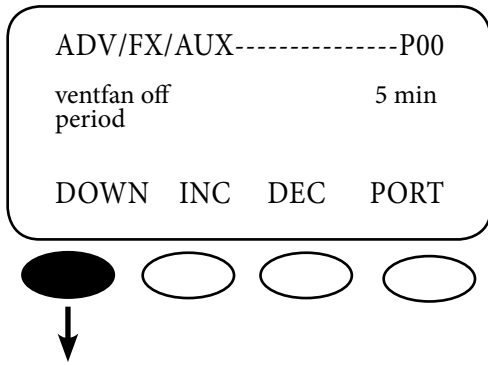

- If a ventilation fan is only needed intermittently, the **ventfan off period** shuts the fan off for a user-determined time before starting up again for a one-minute period when the battery voltage exceeds the ventfan on setpoint. This off period can be set from 0-30 minutes in one-minute increments using the **<INC>** and **<DEC>** soft keys. Setting this period to zero will keep the fan running the entire time the battery voltage is high enough to activate the ventfan function. Setting it to five minutes means the fan will run for one minute and then shut off for five minutes until the battery voltage drops and the fan is no longer needed. Press the **<DOWN>** soft key to view the **diversion on setpoint** screen.

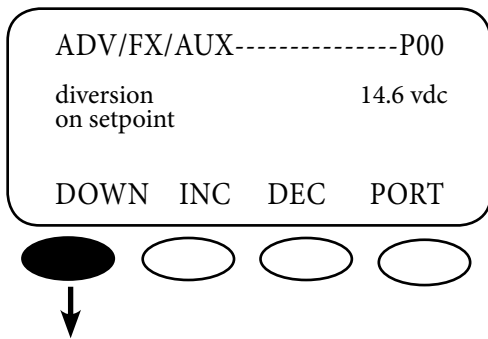

- After deciding on Divert DC or Divert AC, use the **diversion on setpoint** screen to choose the voltage which will activate this AUX OUTPUT FUNCTION. This value can range from 12.0 VDC-16.0 VDC and can be adjusted in 0.1 VDC increments using the **<INC>** and **<DEC>** soft keys. Press the **<DOWN>** soft key to view the **diversion off delay** screen.

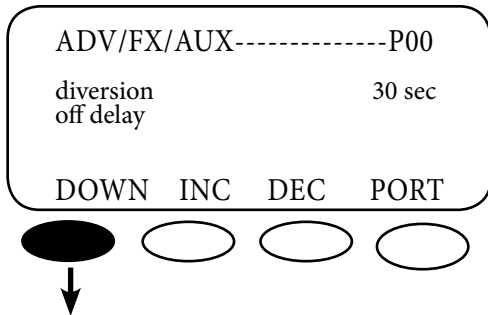

- The **diversion off relay** determines how long the AUX will be energized after the battery voltage which caused the diversion falls below the **diversion on setpoint**. This delay can range from 0-240 seconds in one-second increments as adjusted with the **<INC>** and **<DEC>** soft keys.



## BATTERY CHARGING INSTRUCTIONS

Keeping your battery bank energized is very important. Although a battery bank can last for many years if properly cared for, it can also be ruined in a short period of time if neglected.

### Battery Charging Setpoints

To preserve your batteries *always follow your battery manufacturer's recommendations using the following information:*

- Absorb Voltage
- Float Voltage
- Equalize Voltage
- Recommended Depth of Discharge (DOD) of the batteries

These Absorb, Float, and Equalize voltage set points should be programmed into the FX through the MATE (see MATE User Manual).

## MAINTENANCE

Please contact OutBack Power Systems Technical Services for any FX repairs due to malfunctions or damage. For routine, user-approved maintenance:

- Disconnect all circuit breakers and related electrical connections before doing any cleaning or adjustments.
- Solar modules may produce hazardous voltages when exposed to light; cover them with opaque material before servicing any connected equipment.
- If a remote start system is used, disable the automatic starting circuit while servicing it to prevent starting while servicing.

12 VDC system	DEFAULT	MINIMUM	MAXIMUM
Float Voltage	13.6	12	15
Absorb Voltage	14.4	13	16
EQ Voltage	14.4 ▶	14	17 ▶ (24VDC Grid-Tie is 29.2 default)
ReFloat	12.5	11	13
LBCO	10.5	9	12
LBCI	12.5	10	14
Sell RE	13.0	10	15
<b>GenAlert</b>			
Off Set Point	14	12	18V
On Set Point	11	10	14V
Load Shed off Set Point	11	10	14V
Vent Fan ON set Point	13	10	16V
Diversion On Set Point	14.6	12	16V
Absorb Time	1.0 hours	0.0 hours	24.0 hours
EQ Time	1.0 hours	0.0 hours	24.0 hours
Float Time	1.0 hours	0.0 hours	24.0 hours
AC2/Gen Transfer Delay (Cycles for AC)	60 cycles* *20 for Grid-Tie	0 cycles	240 cycles
Search	6	0	50
Grid Lower Limit	108	40	115
Export Grid Lower Limit Only	208	80	220
Grid Upper Limit (USA)	140	130	150
Grid Upper Limit (Export)	270	250	300
Grid Connect Delay	.5 min	.2 MIN	15.0 min
Drop or Use	USE	N/A	N/A
Charger Off/Auto/On	AUTO		
Aux Output Option	COOL FAN		
Gen Alert On Delay	4 min	0 min	240 min
Gen Alert Off Delay	9 min	0 min	240 min
Vent Fan Off Delay	5 min	0 min	30 min
Gen Window Lower Limit 60 Hz	108	40	115
Export Only	208	80	220
Gen Upper Window Limit 60 Hz	140	130	150v
Export Only	270	250	300
Ac 1/Grid Transfer Delay (Cycles of AC)	6	0	240
Set AUX Control	AUTO		
Search Pulses	8	2	20
Search Pulse Spacing (Cycles AC)	60	4	120
Stacking Phase	1 or 2 Phase		
InPut Select	Master Gen		
Charge Rates for Vented 24 & 48 VDC	18 Amp AC	0 Amp AC	20 Amp AC
Charge Rates for Vented 12 VDC	12 Amp AC	0 Amp AC	14 Amp AC
Charge Rates for Sealed 24 & 48 VDC	10 Amp AC	0 Amp AC	14 Amp AC
Charge Rates for Sealed 12 VDC	10 Amp	0 Amp AC	12 Amp AC
<b>Grid Input Settings</b>			
Set AC Input Size	28 Amp		
Mobile	48 Amp	5 Amp	30 Amp
Non-Mobile (US)	28 Amp	5 Amp	60 Amp
Export	50 Amp	5 Amp	30 Amp
GT			
<b>Gen Input Settings</b>			
Mobile	28		30
Non-Mobile (US)	48	2	60
Export	28	2	30
GT	50	2	
Set VAC (US)	120		125V
Export	230	110	240V
Export		210	

E models are one-half of these values

Correction Factor  
 24 VDC: Multiply 12VDC values by 2  
 32 VDC: Multiply 12 VDC values by 2.64  
 48 VDC: Multiply 12VDC values by 4

FX Default Values (subject to change with FX upgrades)

## WARRANTY

### OutBack Power Systems Two Year Limited Warranty

OutBack Power Systems Inc. warrants that the products it manufactures will be free from defects in materials and workmanship for a period of two (2) years subject to the conditions set forth below.

The limited warranty is extended to the original user and is transferable. The limited warranty term begins on the date of invoice to the original user of the product. The limited warranty does not apply to any product or part thereof damaged by a) alteration or disassembly, b) accident or abuse, c) corrosion, d) lightning, e) reverse polarity, f) repair or service provided by an unauthorized repair facility, g) operation or installation contrary to instructions pertaining to the product.

OutBack Power Systems' liability for any defective product or any part thereof shall be limited to the repair or replacement of the product, at OutBack Power Systems' discretion. OutBack Power Systems does not warrant or guarantee the workmanship performed by any person or firm installing its products.

THIS LIMITED WARRANTY GIVES YOU SPECIFIC LEGAL RIGHTS, AND YOU MAY ALSO HAVE OTHER RIGHTS THAT VARY FROM STATE TO STATE (OR JURISDICTION TO JURISDICTION). OUTBACK POWER SYSTEMS' RESPONSIBILITY FOR MALFUNCTIONS AND DEFECTS IN HARDWARE IS LIMITED TO REPAIR AND REPLACEMENT AS SET FORTH IN THIS LIMITED WARRANTY STATEMENT. ALL EXPRESS AND IMPLIED WARRANTIES FOR THE PRODUCT, INCLUDING BUT NOT LIMITED TO ANY IMPLIED WARRANTIES OF AND CONDITIONS OF MERCHANTABILITY AND FITNESS FOR A PARTICULAR PURPOSE, ARE LIMITED IN DURATION TO THE LIMITED WARRANTY PERIOD SET FORTH ABOVE AND NO WARRANTIES, WHETHER EXPRESS OR IMPLIED, WILL APPLY AFTER SUCH PERIOD. SOME STATES (OR JURISDICTIONS) DO NOT ALLOW LIMITATIONS ON HOW LONG AN IMPLIED WARRANTY LASTS, SO THE ABOVE LIMITATION MAY NOT APPLY TO YOU.

OUTBACK POWER SYSTEMS DOES NOT ACCEPT LIABILITY BEYOND THE REMEDIES SET FORTH IN THIS LIMITED WARRANTY STATEMENT OR LIABILITY FOR INCIDENTAL OR CONSEQUENTIAL DAMAGES, INCLUDING WITHOUT LIMITATION ANY LIABILITY FOR PRODUCTS NOT BEING AVAILABLE FOR USE. SOME STATES (OR JURISDICTIONS) DO NOT ALLOW THE EXCLUSION OR LIMITATION OF INCIDENTAL OR CONSEQUENTIAL DAMAGES, SO THE ABOVE EXCLUSION OR LIMITATION MAY NOT APPLY TO YOU.

During the two year period beginning on the invoice date, OutBack Power Systems will repair or replace products covered under this limited warranty that are returned to OutBack Power Systems' facility or to an OutBack Power Systems authorized repair facility, or that are repaired on site by an OutBack Power Systems authorized repair technician. To request limited warranty service, you must contact OutBack Power Systems at 360-435-6030 within the limited warranty period. If limited warranty service is required, OutBack Power Systems will issue a Return Material Authorization (RMA) Number. Mark the outside of the package with the RMA number and include a copy of the purchase invoice in the package. You must ship the products back to OutBack Power Systems in their original or equivalent packaging, prepay shipping charges, and insure the shipment or accept the risk of loss or damage during shipment. OutBack Power Systems will ship the repaired or replacement products to you freight prepaid if you use an address in the continental United States, where applicable. Shipments to other locations will be made freight collect.

## PRODUCT REGISTRATION

Your purchase of an OutBack Power Systems product is an important investment. Registering your products will help us maintain the standard of excellence you expect from us in terms of performance, quality and reliability.

*Please take a moment to register and provide us with some important information.*

---

NAME: \_\_\_\_\_ E-MAIL: \_\_\_\_\_  
 ADDRESS: \_\_\_\_\_ SOLD BY: \_\_\_\_\_  
 CITY: \_\_\_\_\_ INSTALLER: \_\_\_\_\_  
 STATE: \_\_\_\_\_ ZIP CODE: \_\_\_\_\_ PURCHASE DATE: \_\_\_\_\_  
 COUNTRY: \_\_\_\_\_ MODEL NUMBER: \_\_\_\_\_  
 TELEPHONE NUMBER: \_\_\_\_\_ SERIAL NUMBER: \_\_\_\_\_

---

Circle all that apply:

- |   |   |   |
|---|---|---|
| <input type="checkbox"/> Off-Grid Installation          | <input type="checkbox"/> Residential Installation | <input type="checkbox"/> North America Location |
| <input type="checkbox"/> Utility Connected Installation | <input type="checkbox"/> Commercial Installation  | <input type="checkbox"/> Other _____            |

## EXTENDED WARRANTY APPLICATION (U.S. AND CANADA ONLY)

OutBack Power Systems offers an optional three year extension to the standard two year limited warranty. Purchase of extended warranty coverage is available on products listed below provided conditions shown are met. Extended warranty coverage must be purchased within 90 days of the original sale of the product covered.

<b>PRODUCT COST</b>	<b>REQUIRED SURGE PROTECTION</b>	<b>EXTENDED WARRANTY</b>
Any FX Series Inverter/Charger	AC Input; AC Output, DC Input	\$300.00
OutBack Charge Controller	DC Input; DC Output	\$100.00
MATE	NA	\$50.00
HUB 4	NA	\$35.00
HUB 10	NA	\$50.00

<b>Product Covered</b>	<b>Serial Number</b>	<b>Quantity</b>	<b>Extended Warranty Cost</b>
_____	_____	_____	_____
_____	_____	_____	_____
_____	_____	_____	_____
_____	_____	_____	_____
			Total _____

Send check or money order payable to OutBack Power Systems. Washington residents please include 8.5% sales tax. Include a completed copy of this application and send to:

OutBack Power Systems  
 Extended Warranty Program  
 19009 62nd Ave NE • Arlington, WA 98223 USA

## **10-YEAR LIMITED WARRANTY (California)** **GTFX, GVFX and PS1 Products**

OutBack Power Systems, Inc. ("OutBack") provides a ten-year (10) limited warranty ("Warranty") against defects in materials and workmanship for its GTFX, GVFX and PS1 products ("Products") if installed in fixed location applications within the State of California.

For this Warranty to be effective, the Product purchaser must complete and submit the applicable Product registration card within ninety (90) days of the eligible Product's first retail sale. The term of this Warranty is governed by the date issued by OutBack on the 10-year Warranty Certificate. This Warranty applies to the original OutBack Product purchaser, and is transferable only if the Product remains installed in the original use location. The warranty does not apply to any Product or Product part that has been modified or damaged by the following:

- Installation or Removal;
- Alteration or Disassembly;
- Normal Wear and Tear;
- Accident or Abuse;
- Corrosion;
- Lightning;
- Repair or service provided by an unauthorized repair facility;
- Operation contrary to manufacturer product instructions;
- Fire, Floods or Acts of God;
- Shipping or Transportation;
- Incidental or consequential damage caused by other components of the power system;
- Any product whose serial number has been altered, defaced or removed; or
- Any other event not foreseeable by OutBack.

OutBack's liability for any defective Product, or any Product part, shall be limited to the repair or replacement of the Product, at OutBack's discretion. OutBack does not warrant or guarantee workmanship performed by any person or firm installing its Products. This Warranty does not cover the costs of installation, removal, shipping (except as described below), or reinstallation of Products.

To request warranty service, you must contact OutBack Technical Services at (360) 435-6030 or support@outbackpower.com within the effective warranty period. If warranty service is required, OutBack will issue a Return Material Authorization (RMA) number. A request for an RMA number requires all of the following information:

1. Proof-of-purchase in the form of a copy of the original Product purchase invoice or receipt confirming the Product model number and serial number;
2. OutBack issued 10-year warranty certificate;
3. Description of the problem; and
4. Shipping address for the repaired or replacement equipment.

After receiving the RMA number, pack the Product(s) authorized for return, along with a copy of the original purchase invoice and warranty certificate, in the original Product shipping container(s) or packaging providing equivalent protection and mark the outside clearly with the RMA number. The sender must prepay all shipping charges, and insure the shipment, or accept the risk of loss or damage during shipment. OutBack is not responsible for shipping damage caused by improperly packaged Products, the repairs this damage might require, or the costs of these repairs. If, upon receipt of the Product, OutBack determines the Product is defective and that the defect is covered under the terms of this Warranty, OutBack will then and only then ship a repaired or replacement Product to the purchaser freight prepaid, non-expedited, using a carrier of OutBack's choice within the continental United States, where applicable.

Shipments to other locations will be made freight collect. The warranty period of any repaired or replacement Product is twelve (12) months from the date of shipment from OutBack, or the remainder of the initial warranty term, whichever is greater.

THIS LIMITED WARRANTY IS THE EXCLUSIVE WARRANTY APPLICABLE TO OUTBACK PRODUCTS. OUTBACK EXPRESSLY DISCLAIMS ANY OTHER EXPRESS OR IMPLIED WARRANTIES OF ITS PRODUCTS, INCLUDING BUT NOT LIMITED TO ANY IMPLIED WARRANTIES OF MERCHANTABILITY OR FITNESS FOR A PARTICULAR PURPOSE. OUTBACK ALSO EXPRESSLY LIMITS ITS LIABILITY IN THE EVENT OF A PRODUCT DEFECT TO REPAIR OR REPLACEMENT IN ACCORDANCE WITH THE TERMS OF THIS LIMITED WARRANTY AND EXCLUDES ALL LIABILITY FOR INCIDENTAL OR CONSEQUENTIAL DAMAGES, INCLUDING WITHOUT LIMITATION ANY LIABILITY FOR PRODUCTS NOT BEING AVAILABLE FOR USE OR LOST REVENUES OR PROFITS, EVEN IF IT IS MADE AWARE OF SUCH POTENTIAL DAMAGES. SOME STATES (OR JURISDICTIONS) MAY NOT ALLOW THE EXCLUSION OR LIMITATION OF WARRANTIES OR DAMAGES, SO THE ABOVE EXCLUSIONS OR LIMITATIONS MAY NOT APPLY TO YOU.



## 10-YEAR WARRANTY REGISTRATION - CALIFORNIA

**To request a 10-year Limited Warranty; complete this form along with a check or money order in the amount of \$599 USD payable to OutBack Power Systems, Inc., and return it to:**

Outback Power Systems Inc.  
19009 62nd Ave. NE • Arlington, WA 98223

**NOTE: A 10-Year Limited Warranty Certificate will only be issued if this registration card is received by Outback within 90 days of the date of the first retail sale of the eligible product.** Please submit a copy (not the original) of the product purchase invoice, which confirms the date and location of purchase, the price paid, and the product model and serial number. The warranty certificate is available only for and will only be issued for GTFX, GVFX and PS1 products installed in fixed location (non-mobile) applications within the state of California.

### 10-Year Warranty Registration for GVFX, GTFX and PS1-California

#### System Owner

Name: \_\_\_\_\_

E-mail: \_\_\_\_\_

Address: \_\_\_\_\_

City, State, Zip Code: \_\_\_\_\_

Country: \_\_\_\_\_

Telephone number: \_\_\_\_\_

#### Product

Product model number: \_\_\_\_\_

Product serial number: \_\_\_\_\_

Sold by: \_\_\_\_\_

Purchase date: \_\_\_\_\_

Please circle the three most important factors affecting your purchase decision:

- Price
- Product Reputation
- Product Features
- Reputation of OutBack Power
- Value

#### System

System install/commission date: \_\_\_\_\_

System array size: \_\_\_\_\_

System array nominal voltage: \_\_\_\_\_

Type of PV modules: \_\_\_\_\_

System battery bank size (amp hours): \_\_\_\_\_

Type of batteries: \_\_\_\_\_

Please list other sources of back-up power: \_\_\_\_\_

\_\_\_\_\_

\_\_\_\_\_

#### Installer

Installer: \_\_\_\_\_

Installer e-mail: \_\_\_\_\_

Installer address: \_\_\_\_\_

Installer City, State, Zip: \_\_\_\_\_

Contractor number: \_\_\_\_\_







19009 62nd Avenue NE  
Arlington, WA 98223 USA  
(+1) 360.435.6030

European Sales Office  
Barcelona, ESPAÑA  
(+34) 600.843.845

[www.outbackpower.com](http://www.outbackpower.com)

900-0087-01-00 REV A